

# SPECTRE

## USER GUIDE



 **TRNDlabs**



[www.trndlabs.com](http://www.trndlabs.com)

# Welcome to the world of TRNDlabs products!

TRNDlabs products are design focused electronics, engineered to combine ultimate performance and aesthetics.

## Learn how to fly!

TRNDlabs Drone Academy is a video platform where you can get your drone up and running in minutes!

[www.trndlabs.academy](http://www.trndlabs.academy)

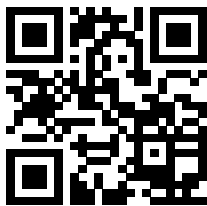

DRONE

**ACADEMY**

# Table of Contents

	<b>6</b>	<b>Parts Identification</b>	
Drone Functions	7	<b>7</b>	<b>Functions</b>
Controller Functions	7		
	<b>8</b>	<b>8</b>	Charging SPECTRE
Setup		8	Controller Battery Installation
		9	Mobile Phone Installation
		9	Rotor Protector Installation
	<b>10</b>	<b>10</b>	<b>Pairing</b>
Auto Take-Off & Land	11	<b>11</b>	<b>Piloting</b>
Flight Controls	12		
	<b>14</b>	<b>14</b>	App Installation
Setup App		15	Connecting
		15	App Functions
		16	Back to Home
		16	Show/Hide Buttons
Taking a Photo	17	<b>17</b>	<b>Photo &amp; Video</b>
Recording a Video	17		
Playing Back Videos/Viewing Photos	18		
	<b>19</b>	<b>19</b>	Switching VR Mode ON/OFF
VR Mode			

Tips & Tricks	20	20	Sensitivity Control
		21	Switching Modes
		22	Advanced Flight: Performing 360° Flips
Direction Trim	25	25	Troubleshooting
Rotation Trim	26		
Calibration	26		
Replacing Rotor Blades	27		
FAQ	28		
Safety Precautions	29	30	Additional Safety Precautions
		31	Battery Safety Instructions
		31	FCC Compliance Information (USA only)

# Parts Identification

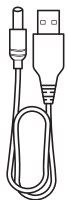

USB  
Charging  
Cable

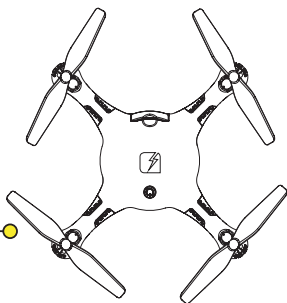

SPECTRE

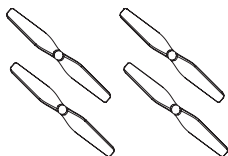

Replacement Rotor Blades (4x)

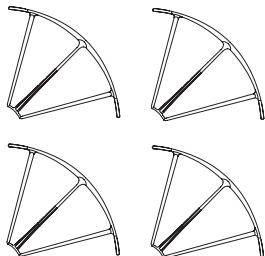

Rotor Protectors (4x)

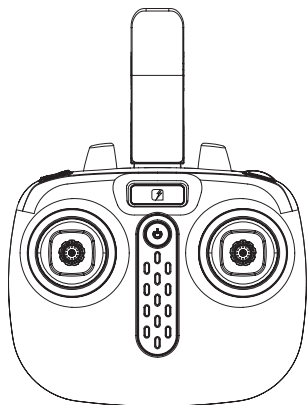

Screwdriver



Controller

# Functions

## Drone Functions

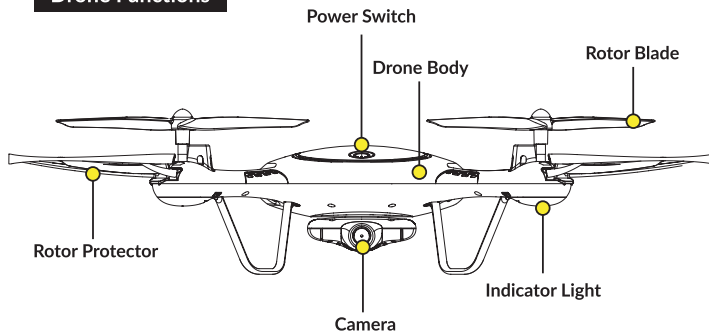

## Controller Functions

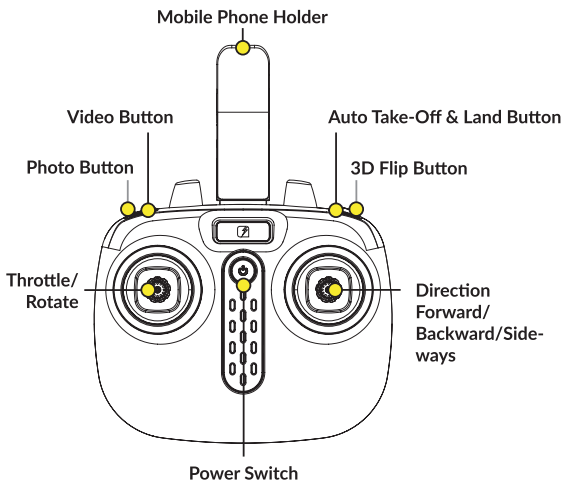

# Setup

## Charging SPECTRE

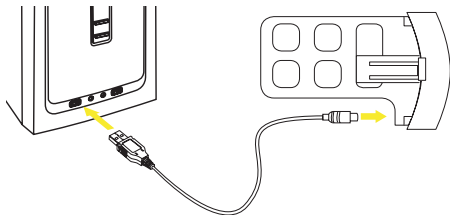

Connect the USB Charging Cable to an USB port and battery. The LED on the USB Charging Cable lights red indicating that the battery of the drone is charging. When the battery is fully charged, the LED on the USB Charging Cable turns off. It takes about 30 minutes to recharge a discharged battery.



WARNING

Make sure you only charge the rechargeable battery with the supplied USB Charging Cable. Trying to charge the rechargeable battery with a different battery charger might cause serious damage.

## Controller Battery Installation

- 1 Open the Controller battery cover.
- 2 Install 4x 1.5V AA batteries.
- 3 Slide the Controller battery cover back.

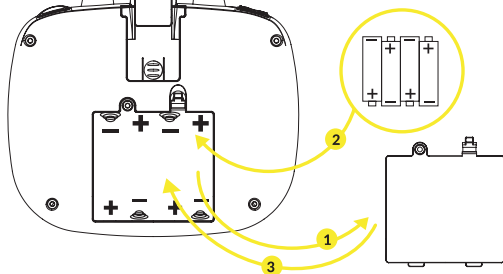

## Mobile Phone Installation

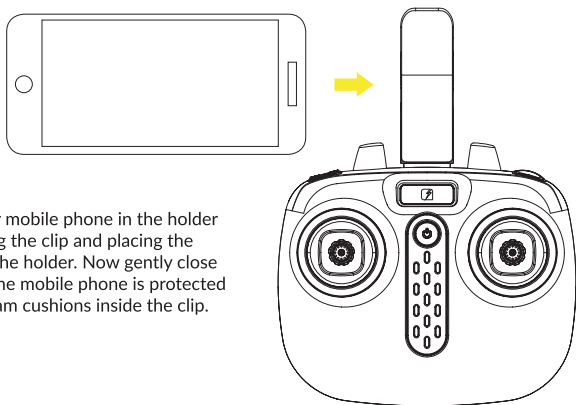

Place your mobile phone in the holder by opening the clip and placing the phone in the holder. Now gently close the clip. The mobile phone is protected by two foam cushions inside the clip.

## Rotor Protector Installation

Gently slide the Rotor Protectors onto the landing feet of the drone (4x).

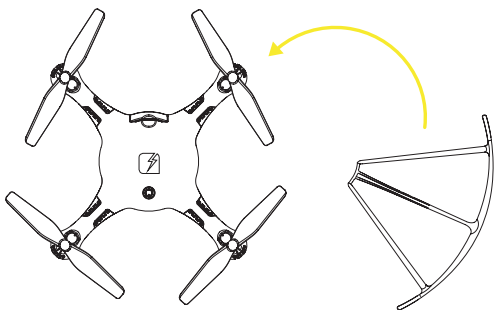

# Pairing

Place the drone on a flat and level surface.

- 1 Press the Power Switch of the drone for 2 seconds. The LED lights of the drone start flashing rapidly.
- 2 Press the Power Switch to turn on the Controller. The Indicator Light on the Controller starts flashing rapidly.
- 3 Push the Throttle/Rotate stick to the full up position, then to the full down position. The Controller Indicator Light and the LED lights of the drone turn solid after a few seconds.
- 4 When the Indicator Light on the Controller and the LEDs on the drone are all solid (not blinking) the drone is ready to fly.

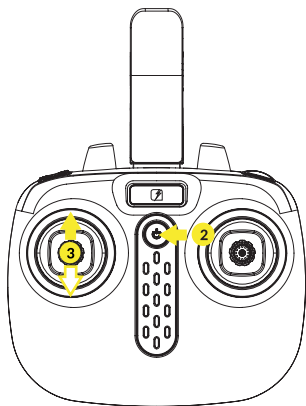
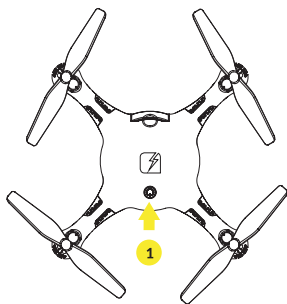

# Piloting

## Auto Take-Off & Land

- 1 Pressing the Auto Take-Off & Land button will cause the rotors of the drone to spin. The drone takes off and will hover at approximately 1.5 meter.
- 2 Pressing the Auto Take-Off & Land button again will make the drone land.

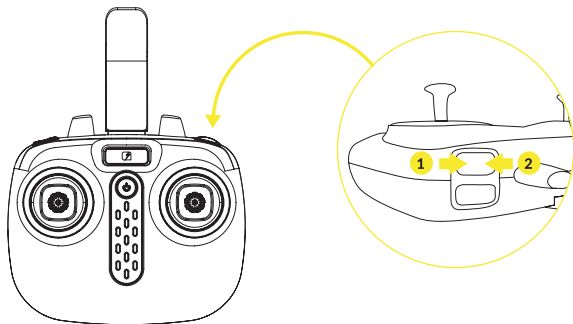

## Throttle Control

To fly higher, push the Throttle/Rotate stick cautiously forward. To fly lower, push the Throttle/Rotate stick cautiously backward.

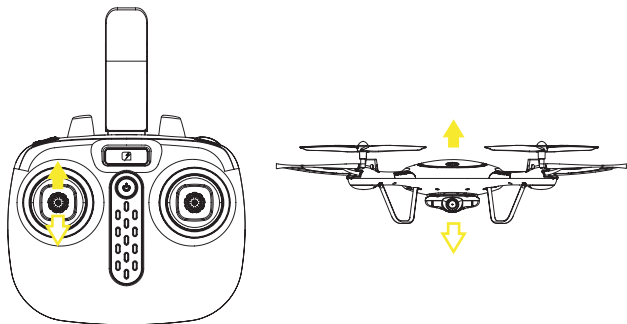

## Flight Controls

### Direction Control

To fly the drone forward or backward, push the Direction stick cautiously forward or backward.

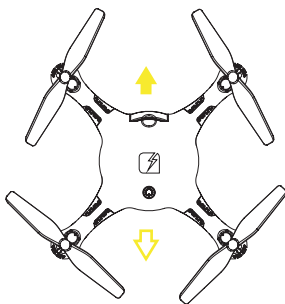
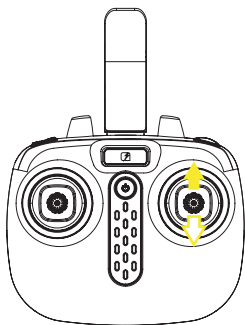

To fly the drone to the left or the right, push the Direction stick cautiously to the left or the right.

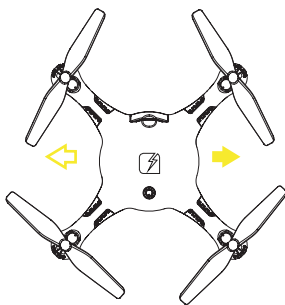
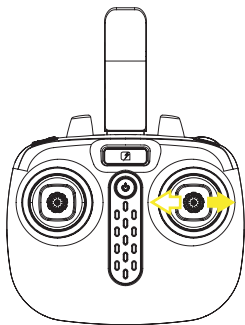

## Rotation Control

To make the drone circle to the left or the right, push the Throttle/Rotate stick cautiously to the left or right.

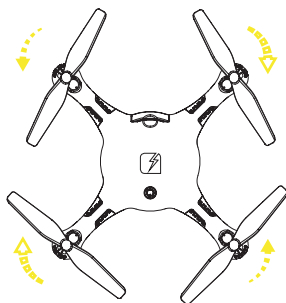
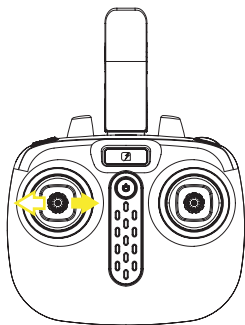

# Setup App

## App Installation

The App is suitable for mobile phones with iOS or Android. The App can be downloaded from the App Store or Google Play.

Scan the QR code to download the App: SPECTRE

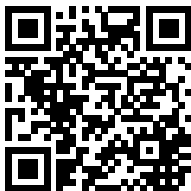

For mobile phones with iOS, search for SPECTRE in the App Store.

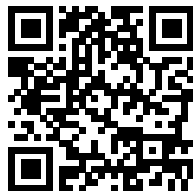

For mobile phones with Android, search for SPECTRE in Google Play.

## Connecting

- 1 Refer to chapter "Pairing" (page 10)
- 2 Enter the settings of your mobile phone and turn on the WiFi.
- 3 Select "FPV\_WIFI\_XXXX" in the list of networks.
- 4 Go back and select the SPECTRE App.
- 5 Tap on the FLY button to enter the Live Video interface.

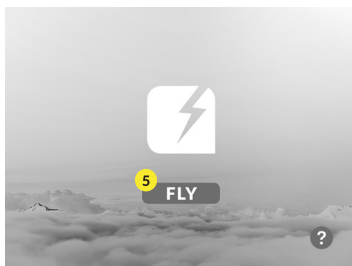

## App Functions

- 1 Back to Home
- 2 Take a Photo
- 3 Record a Video
- 4 View Photos/Videos
- 5 VR Mode
- 6 Help
- 7 Tap on screen to hide/show buttons.

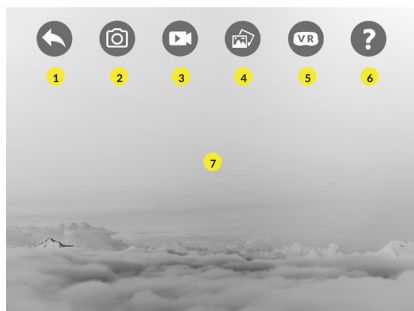

## Back to Home

Tap the back icon to return to the home screen.

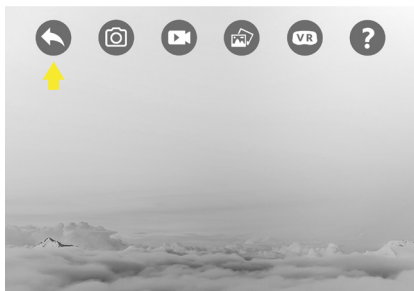

## Show/Hide Buttons

Tap anywhere on the screen to hide the buttons. Tap again to bring up the buttons again.

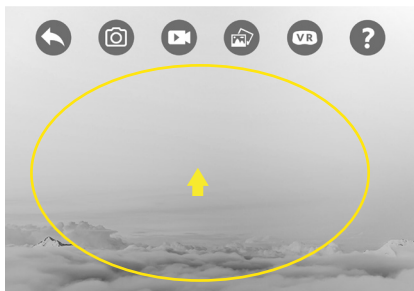

# Photo & Video

## Taking a Photo

Tap the photo icon to take a photo. The icon will flash yellow momentarily, to notify a picture is taken. You can also take a picture with the Photo Button on the controller. The LED lights on the drone will flash momentarily to indicate a picture is being taken.

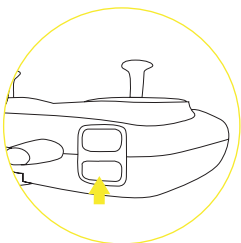
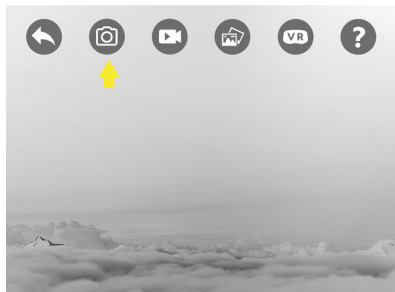

## Recording a Video

Tap the video icon to record a video. The icon will turn yellow when it's recording. Tap the icon again to stop recording, the icon will turn grey again. You can also record a video by pressing the Video Button on the controller. The LED lights on the drone will start flashing to indicate a video is being recorded. Press the button again to stop recording. The LED lights will stop flashing.

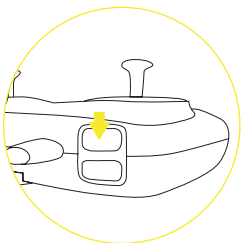
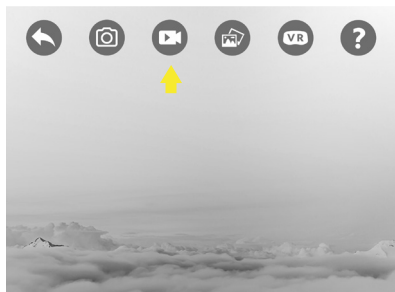

## Playing Back Videos/Viewing Photos

Tap the gallery icon to view photos and videos.

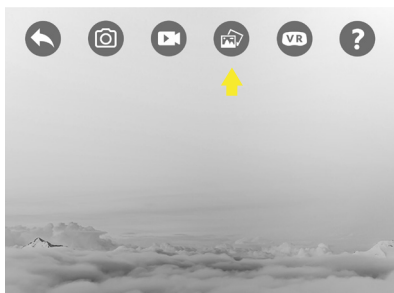

The SD card is mounted in the camera underneath the drone. You can remove the SD card and connect it to your computer via the microSD Card USB Reader. You will find the video files e.g. MOV10000.mov on the SD card in the folder VIDEO. The videos are MOV files. You will find the photo files, e.g. PICT0000.jpg in the folder PHOTO. The photos are JPG files. When reinstalling the SD card, make sure the metal contacts on the SD card are facing in the right direction.

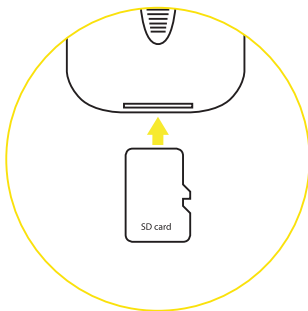

# VR Mode

## Switching VR Mode ON/OFF

Tap the VR Mode button to activate VR Mode. The button will turn yellow and the live feed from the drone will be visible as split screen. Press the button again to switch back to normal view.

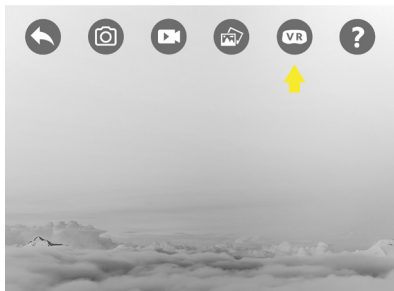

# Tips & Tricks

## Sensitivity Control

The drone has two sensitivity settings: Low and High. The higher sensitivity makes the drone faster and more responsive.

### Controller Sensitivity Control

Press the Direction stick once to change the sensitivity:

- 1 When the Controller emits 1 tone = Low sensitivity mode.
- 2 When the Controller emits 2 tones = High sensitivity mode.

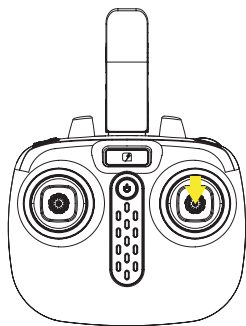

## Switching Modes

The drone can be switched from Normal Mode **A** to Headless Mode. **B** Headless Mode does not require the pilot to differentiate the front (head) position of the drone, but simply use the Direction Stick for the drone to respond correctly to the given input relative to the position of the controller.

To enter Headless Mode, press and hold the Direction Stick for 2 seconds. **1** The controller will emit a series of beeps to confirm the drone is now in headless mode. Press the Direction Stick again for 2 seconds to exit Headless Mode. The controller emits a long beep tone to confirm return to Normal Mode.

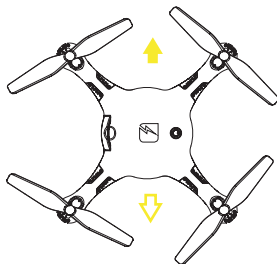
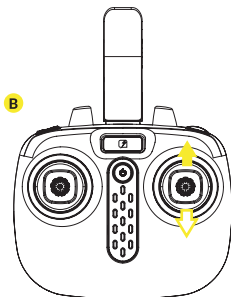
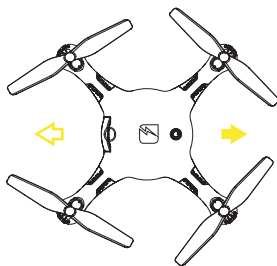
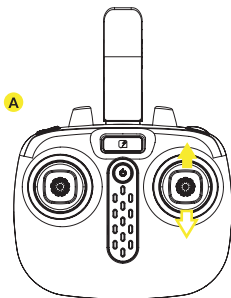
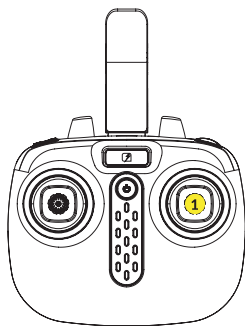

## Advanced Flight: Performing 360° Flips

The drone can perform 360° front flips, back flips and side flips. Press the 3D Flip Button **1**, then push the Direction stick **2** forward, backward, right or left at the same time. The drone carries out the flip in the respective direction.

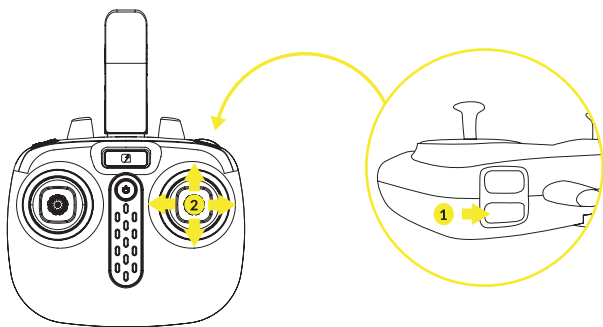

**WARNING**

Do not attempt these stunts until you are able to fly confidently. Choose an area that will provide a soft landing (carpet or grass) and maintain an altitude of at least 10 feet/3 meter to allow room to recover control as you practice flipping the drone.

### Left Side 360° Flip

Press the 3D Flip Button and push the Direction stick to the left at the same time.

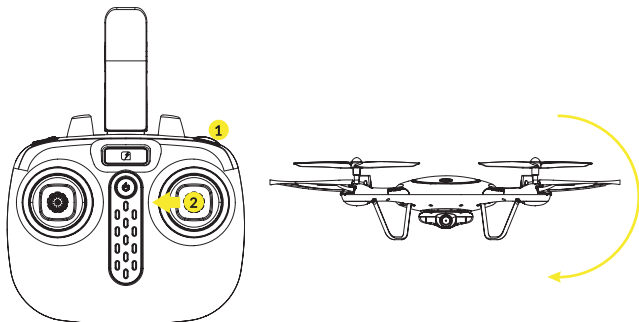

### Right Side 360° Flip

Press the 3D Flip Button and push the Direction stick to the right at the same time.

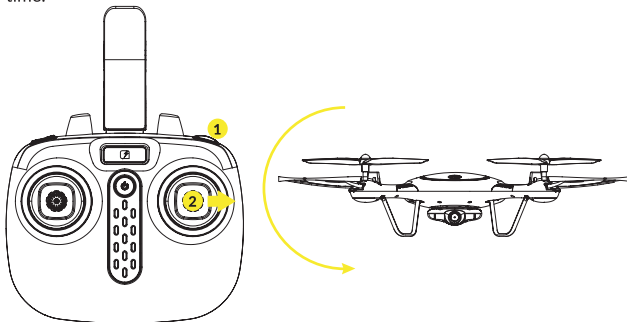

## Forward 360° Flip

Press the 3D Flip Button and push the Direction stick forward at the same time.

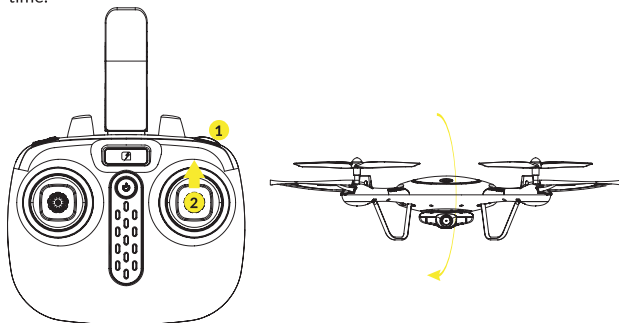

## Backward 360° Flip

Press the 3D Flip Button and push the Direction stick backward at the same time.

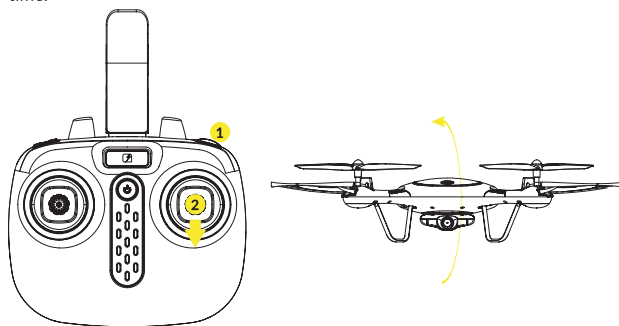

# Troubleshooting

## Direction Trim

When hovering, if the drone flies forward or backward without moving the Direction stick, proceed as follows:

If the drone moves on its own forward/backward, press down the left joystick **1** and at the same time push the right joystick forward/backward **2** to compensate for the direction deviation. Keep the left joystick pressed down and keep trimming with the right joystick until the drone flies stable.

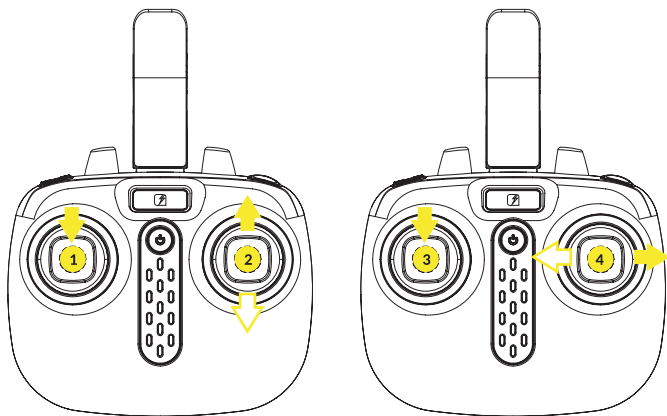

When hovering, if the drone flies to the left or right without moving the Direction stick, proceed as follows:

If the drone moves on its own to the left/right side, press down the left joystick **3** and at the same time push the right joystick to the left/right **4** to compensate for the direction deviation. Keep the left joystick pressed down and keep trimming with the right joystick until the drone flies stable.

## Rotation Trim

When hovering, if the drone rotates to the left or right without you moving the Throttle/Rotate stick, proceed as follows:

Press down and hold the left joystick. **1** While keeping the left joystick pressed, move it to the left/right to compensate for the rotation deviation. Keep the left joystick pressed down and keep trimming until the drone flies stable.

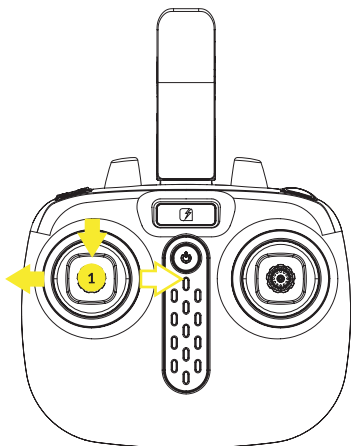

## Calibration

The drone needs to be calibrated if it flies unstable.

Place the drone on a flat and level surface. Now push both the left and right joystick, at the same time, to the lower right corners and hold for 2 to 3 seconds. The LED lights on the drone will start blinking rapidly, indicating the drone is calibrating. After 2 to 3 seconds the LED lights will return back to normal, indicating the calibration was successful.

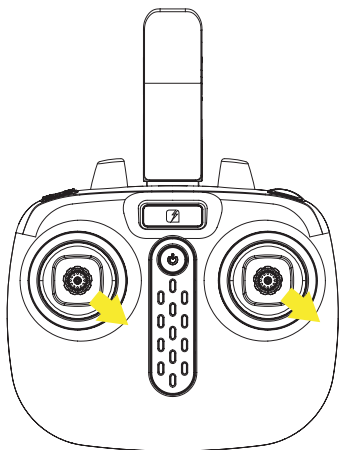

## Replacing Rotor Blades

To replace a rotor blade, follow the steps below:

- 1 Gently remove the protector cap from the rotor top.
- 2 Use the Screwdriver to remove the screw.
- 3 Gently remove the rotor blade.
- 4 Press the new rotor blade onto the motor axis.
- 5 Fix the rotor blade by tightening the screw with the screw driver.
- 6 Put the protector cap back in place and press it gently.

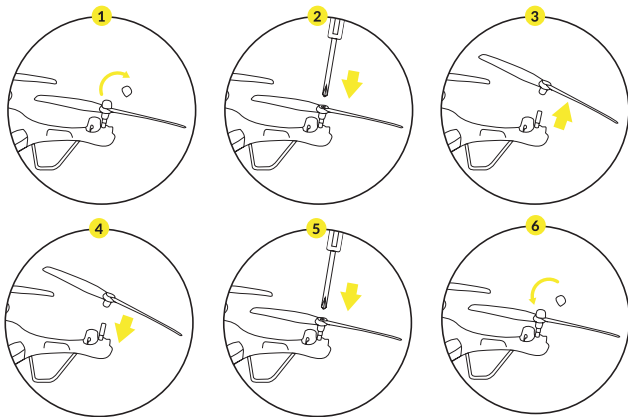

Each rotor blade is marked with a "B" followed by a number at the underside. Be sure to note the marking and the tilt angle of the rotor blades.

Front left: marking "1" or "3"  
Front right: marking "2" or "4"  
Rear left: marking "2" or "4"  
Rear right: marking "1" or "3"

The "B" preceding the number can be ignored.

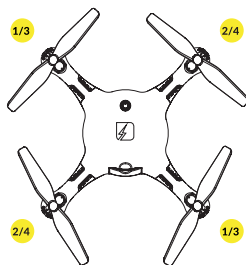

## FAQ



**Problem:** Controller does not work.



**Cause:** The batteries have been incorrectly inserted.

**Solution:** Check if the batteries have been correctly inserted.

**Cause:** The batteries do not have enough power.

**Solution:** Insert new batteries.



**Problem:** The drone cannot be controlled with the controller.



**Cause:** The controller is possibly not correctly paired with the drone.

**Solution:** Carry out the pairing procedure as described in "Pairing" (page 10).



**Problem:** The drone does not lift.



**Cause:** The battery power is not sufficient.

**Solution:** Charge the battery as described in "Charging SPECTRE" (page 8).



**Problem:** During flight, the drone loses speed and height without any obvious reason.



**Cause:** The battery is too weak.

**Solution:** Charge the battery as described in "Charging SPECTRE" (page 8).



**Problem:** The drone only flies in a circle or flips over before taking off.



**Cause:** Rotor blades incorrectly mounted or damaged.

**Solution:** Fit rotor blades/replace rotor blades as described in "Replacing Rotor Blades" (page 27).



**Problem:** Unable to find photos and videos in App Gallery.



**Solution:** Photos and videos taken with the App are stored on the mobile device and on the SD card of the drone. Photos and videos taken with the controller are stored on the SD card of the drone only.

# Safety Precautions

Carefully follow the instructions below. Make sure you fly the drone safely, and you mind the warnings. The drone is not intended for use by children under fourteen years old, unless directly supervised by a competent adult at all times.

Always ensure the safety of yourself, others and the drone. The drone has rotating blades that move at high speed and might cause damage or danger. Pilots are responsible for any actions that results in damage or injury due to improper operation of the drone.

Make sure you use the drone in a proper environment. Choose an adequate flying space without obstacles.

Keep your hands, face, hair or loose clothes away from the rotating blades. Hair getting into the rotor might cause serious damage to the drone.

Never lose sight of the drone. If the drone flies out of your field of view, immediately stop operating it.

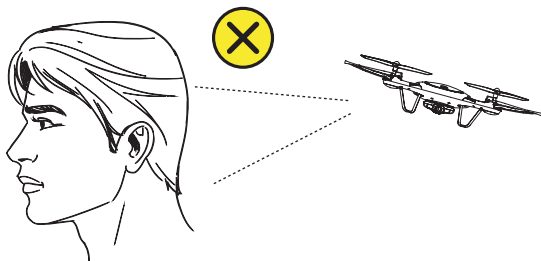
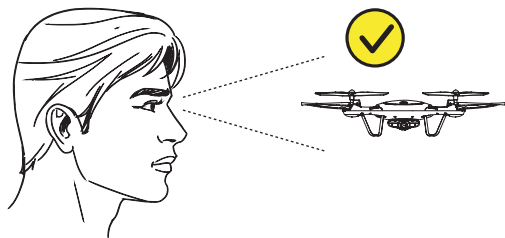

Do not fly near buildings. Do not fly over stations, railways or highways. Do not fly near trees, or crowds of people. Do not fly in rain, snow, fog, storm, wind or in unclear weather conditions at night.

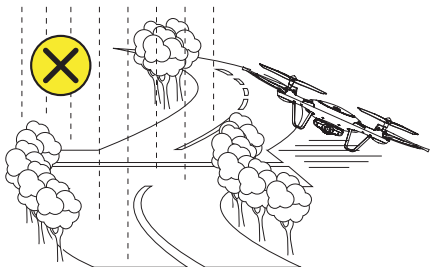

Do not approach or film people without their consent. Be mindful of privacy.

Avoid ceiling fans, hanging light fixtures, heating or air conditioning.

### Additional Safety Precautions

- This drone has small parts that may pose a choking hazard. Keep all small parts and electrical devices out of the reach of children and animals. Pets can become excited by radio-controlled drones.
- The drone is controlled by radio, therefore it is subject to radio interference from many sources that are beyond your control. Radio interference can cause momentary losses of radio control. Always allow a safety margin in all directions around the drone in order to prevent collisions.
- The controller and the charger are specially designed to charge this model. Never use other charging equipments.
- Regularly examine the drone and controller for any damage to the plugs, enclosure, rotor blades, battery covers and other parts. In the event of any damage, neither the drone nor the controller should be used.
- When cleaning the drone or controller, use a damp cloth and wipe gently. Avoid using chemicals, it can damage the plastic components.

## Battery Safety Instructions

- For the best performance, only use fresh 1.5V Alkaline “AAA” batteries in the controller.
- Never operate the drone with low controller batteries
- The drone automatically switches off if the rotors are unable to rotate. Switch the power to restart the drone.
- When not in use, store the drone in the original packaging with the batteries removed from the controller.
- Always recharge the battery after use in order to prevent it becomes deep discharged. Make sure to allow a pause of about 20 minutes between finishing the flight and recharging the battery.
- Even if the drone is not in regular use, recharge the battery occasionally, suggested at least once in every 2-3 months.
- When transporting or temporarily storing the rechargeable battery, the temperature should be between 5-50 C. Do not store the battery or the drone in a car and do not expose it to direct sunlight. In case the battery is overheated it can be damaged or catch fire.
- Do not submerge the drone or the controller in water. This will damage the electronic components and could pose a severe risk to the built-in battery.

## FCC Compliance Information (USA only)

This device complies with part 15 of the FCC Rules. Operation is subject to the following two conditions: (1) This device may not cause harmful interference, and (2) This device must accept any interference received, including interference that may cause undesired operation. Changes or modifications not expressly approved by the party responsible for compliance could void the user's authority to operate the equipment.









The contents of this document are subject to change.  
Download the latest version from  
[www.trndlabs.com](http://www.trndlabs.com).

If you have any questions about this document, please contact TRNDlabs  
by sending a message to [hello@trndlabs.com](mailto:hello@trndlabs.com).

© 2017 TRNDlabs. All rights reserved.



 **TRNDlabs**